

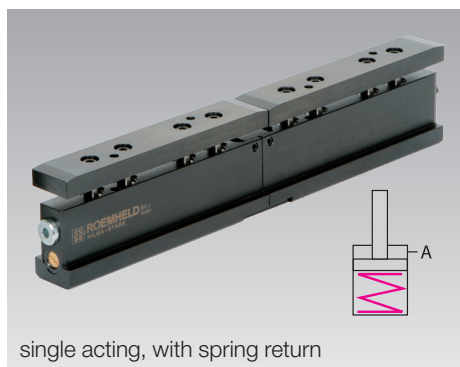

**Double-T Clamping Bars**  
single or double acting,  
max. operating pressure 400 bar

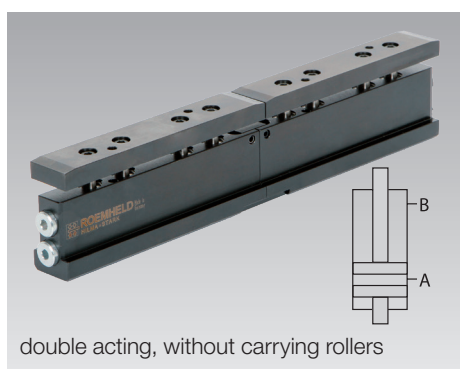

single acting, with spring return



double acting, without carrying rollers

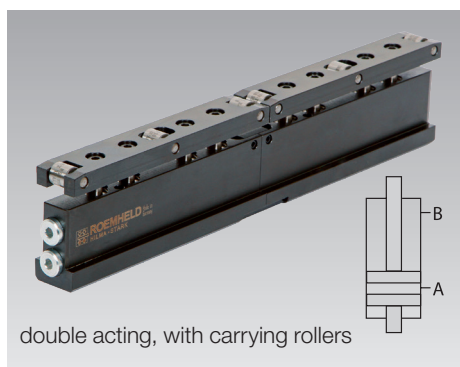

double acting, with carrying rollers

**Application**

- For clamping of dies on the press bed and press ram
- When the available space is limited

**Application example**

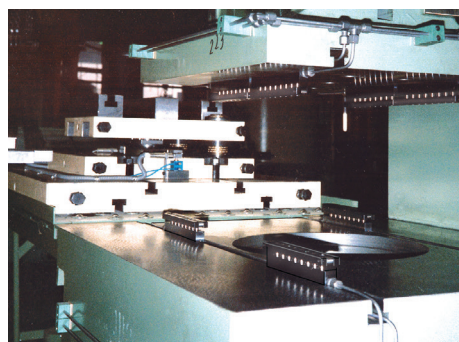

Double-T clamping bar on press bed and ram

**Advantages**

- The complete clamping surface can be used
- No collision edges
- Easy and quick retrofit
- Ideal, uniform force transmission

**Double-T-clamping bar, single acting, with spring return, without carrying rollers**

For use in the press ram, but also suitable for the press bed.

Installation of the double-T clamping bar by insertion into the T-slots of the press ram or the press bed in any desired position. The bar is manually secured in position with locking screws in the T-slot.

The double-T design requires T-slots in the die and in the press ram or press bed.

The clamping force is generated by applying hydraulic pressure to the pistons, and unclamping is carried out mechanically by spring return.

**Double-T-clamping bar, double acting, without carrying rollers**

For use in the press ram, but also suitable for the press bed.

Installation of the double-T clamping bar and generation of the clamping force are as described above, but with one additional clamping circuit for unclamping.

**Double-T clamping bar, double acting, with carrying rollers for lifting and clamping**

preferably for the use in the press bed.

Installation and function as described above, however equipped with carrying rollers.

A double-acting piston causes the lifting of the carrying rollers and the following clamping of the die by a second clamping circuit. Before clamping is made, the die positioned on the carrying rollers is not in contact with the table plate and can be easily moved and positioned. Lifting, moving, positioning and clamping with one element only.

**Insertion chamfer**

If the dies have a slight lateral offset when loading into the machine, the double-T clamping bars are protected by insertion chamfers at the connection side.

Insertion chamfers

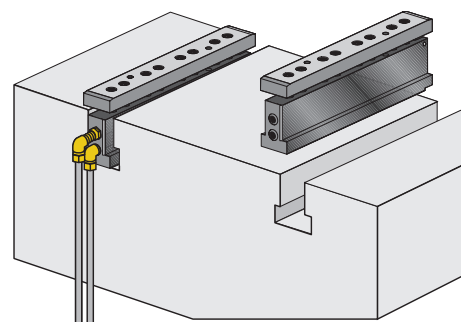
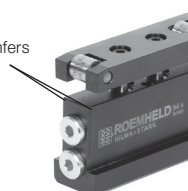

**Accessory guiding bar**

If the die offset is larger (up to 1.5 mm) or the dies are not fed on the connection side of the double-T clamping bars of the machine, we recommend separate guiding bars. They are fastened in the T-slot using clamping bolts. Special guide bar designs are available on request (e.g. with hydraulic ports for the connection side).

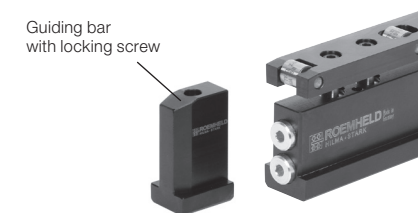

Guiding bar	Part no.
for T-slot 18	<b>7 18320015</b>
for T-slot 22	<b>7 18320016</b>
for T-slot 28	<b>7 18320017</b>

**Important notes**

All double-T bars are composed of modular segments. Thus, different lengths can be delivered. When clamping or unclamping, make sure that there is an overlap of >90 % of the segment length.

- Segment lengths:  
 T-slot 18  $\triangleq$  150 mm  
 T-slot 22  $\triangleq$  300 mm  
 T-slot 28  $\triangleq$  300 mm

## Double-T clamping bars single acting with spring return • without carrying rollers

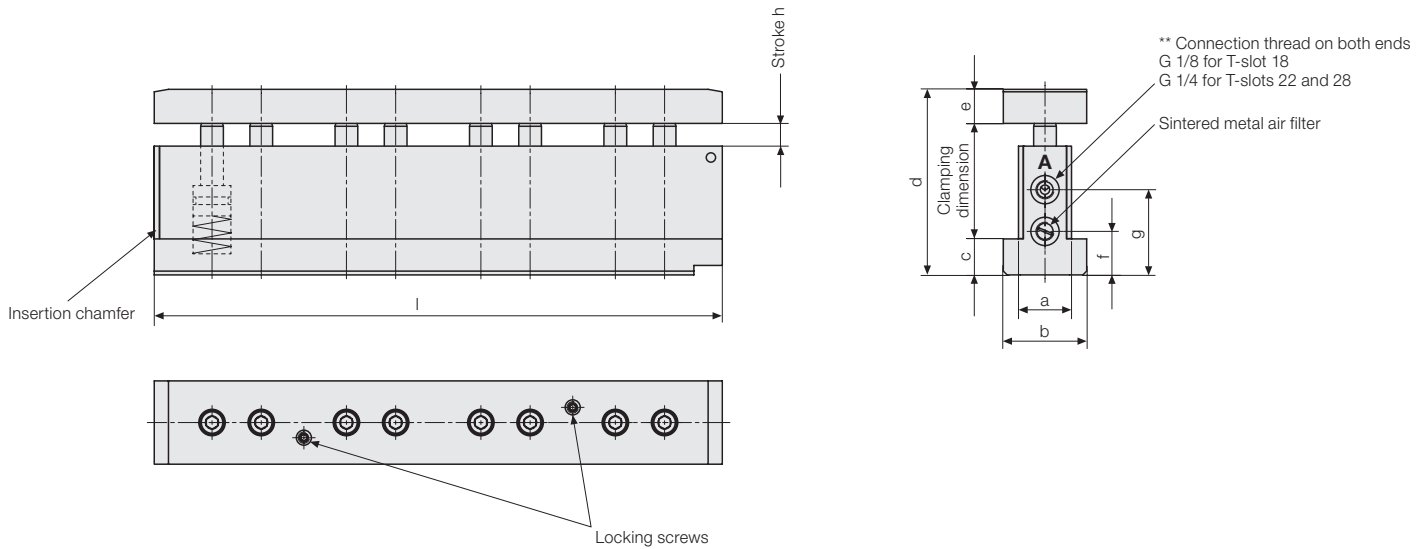

Slot a	[mm]	18	22	28
b	[mm]	28	35	44
c	[mm]	11.5	15.0	19.0
d min.	[mm]	55	70	89
d max.	[mm]	63	80	101
e	[mm]	11	15	18
g	[mm]	30.5	41.0	46.0
Clamping dimension	[mm]	33.5 +6	41.0 +8	53.0 +10
Stroke h*	[mm]	8	10	12
Max. operating pressure	[bar]	400	400	400

\* Reduction of stroke on request

T-slot a [mm]	Length l* [mm]	Clamping force at 400 bar [kN]	Oil volume [cm <sup>3</sup> ] Clamping	Part no.
18	150	16.6	3.3	8 1832 1810**
18	300	33.2	6.6	8 1832 1812
18	450	49.8	9.9	8 1832 1814
18	600	66.4	13.2	8 1832 1816
18	750	83.0	16.6	8 1832 1818
22	300	39.2	3.3	8 1832 2210**
22	600	78.4	19.6	8 1832 2212
22	900	117.6	29.4	8 1832 2214
22	1200	156.8	39.2	8 1832 2216
22	1500	196.0	49.0	8 1832 2218
28	300	64.0	19.3	8 1832 2810**
28	600	128.0	38.6	8 1832 2812
28	900	192.0	57.9	8 1832 2814
28	1200	256.0	77.2	8 1832 2816
28	1500	320.0	96.5	8 1832 2818

\* Intermediate lengths and extra-long bars on request

\*\* Connection thread on one end

## Double-T clamping bars double acting • without carrying rollers

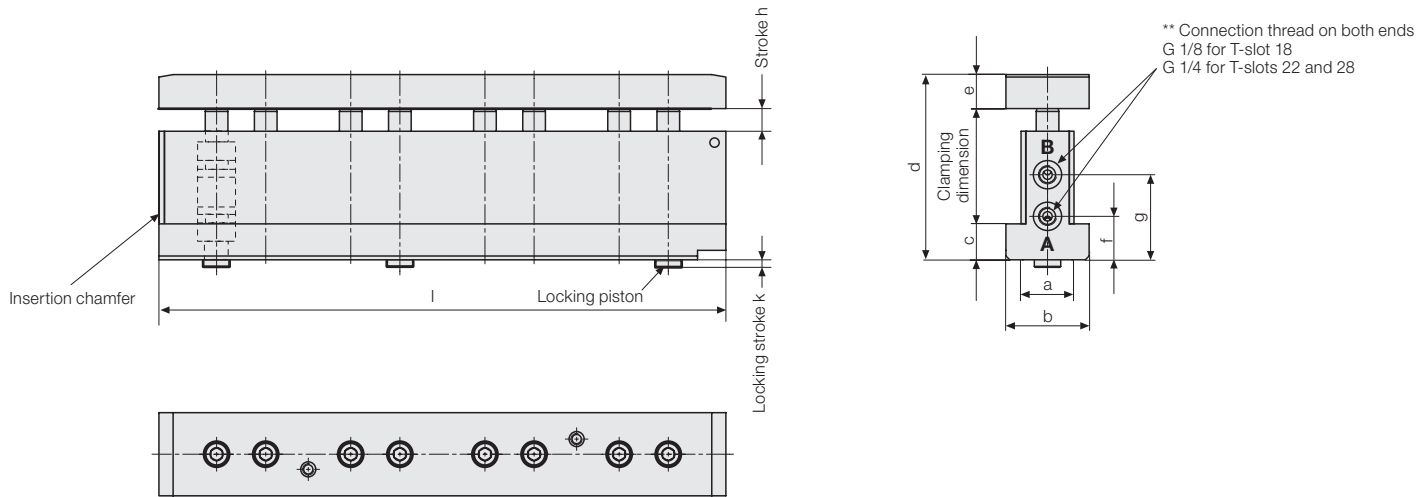

Slot a	[mm]	18	22	28
b	[mm]	28	35	44
c	[mm]	11.5	15.0	19.0
d min.	[mm]	55	70	89
d max.	[mm]	63	80	101
e	[mm]	11	15	18
f	[mm]	13.5	18.0	23.0
g	[mm]	30.5	41.0	46.0
Clamping dimension	[mm]	33.5+6	41.0+8	53.0+10
Stroke h*	[mm]	8	10	12
Locking stroke k**	[mm]	2.5	3.0	4.0
Max. operating pressure	[bar]	400	400	400

\* Reduction of stroke on request

\*\* Locking screw (see double-T bar single-acting) instead of locking piston on request

T-slot a [mm]	Length l* [mm]	Clamping force at 400 bar [kN]	Oil volume [cm <sup>3</sup> ]		Part no.
			Clamping	Unclamping	
18	150	16.6	3.3	6.4	8 1832 1820**
18	300	33.2	6.6	12.9	8 1832 1822
18	450	49.8	9.9	19.4	8 1832 1824
18	600	66.4	13.3	25.8	8 1832 1826
18	750	83.0	16.6	32.3	8 1832 1828
22	300	39.2	9.8	20.9	8 1832 2220**
22	600	78.4	19.6	41.8	8 1832 2222
22	900	117.6	29.4	62.7	8 1832 2224
22	1200	156.8	39.2	83.6	8 1832 2226
22	1500	196.0	49.0	104.5	8 1832 2228
28	300	64.0	19.3	40.2	8 1832 2820**
28	600	128.0	38.6	80.4	8 1832 2822
28	900	192.0	57.9	120.6	8 1832 2824
28	1200	256.0	77.2	160.8	8 1832 2826
28	1500	320.0	96.5	201.0	8 1832 2828

\* Intermediate lengths and extra-long bars on request

\*\* Connection thread on one end

## Double-T clamping bars

double acting • with carrying rollers • for lifting and clamping

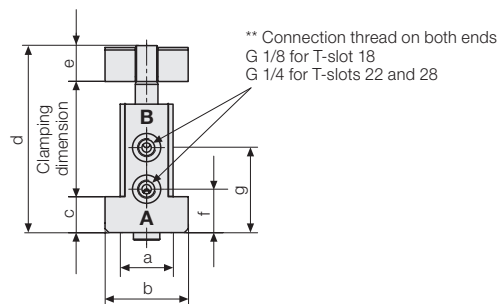
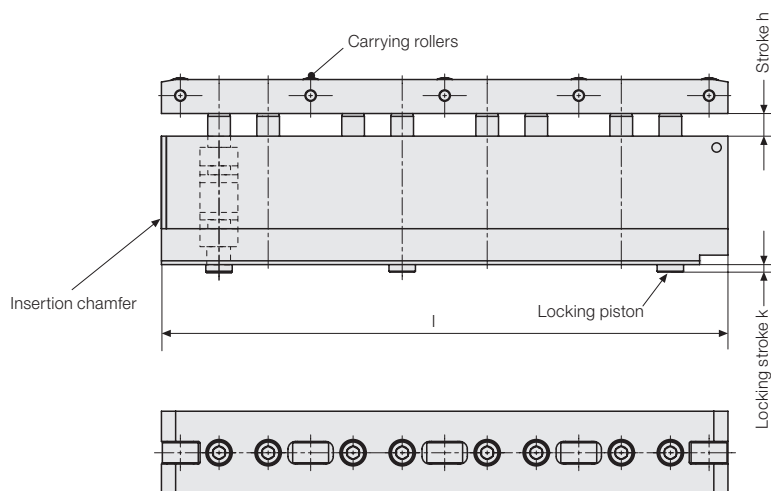

Slot a	[mm]	18	22	28
b	[mm]	28	35	44
c	[mm]	11.5	15.0	19.0
d min.	[mm]	56	71	90
d max.	[mm]	64	81	102
e	[mm]	12	16	19
f	[mm]	13.5	18.0	23.0
g	[mm]	30.5	41.0	46.0
Clamping dimension	[mm]	33.5+6	41.0+8	53.0+10
Stroke h*	[mm]	8	10	12
Locking stroke k**	[mm]	2.5	3.0	4.0
Max. operating pressure	[bar]	400	400	400

\* Reduction of stroke on request

T-slot a [mm]	Length l* [mm]	Load at 400 bar [kN]	Clamping force at 400 bar [kN]	Number of carrying rollers	Oil volume [cm <sup>3</sup> ]		Part no.
					Clamping	Unclamping	
18	150	9	16.6	3	3.3	6.4	818321830**
18	300	18	33.2	6	6.6	12.9	818321832
18	450	27	49.8	9	9.9	19.4	818321834
18	600	36	66.4	12	13.3	25.8	818321836
18	750	45	83.0	15	16.6	32.3	818321838
22	300	32	39.2	5	9.8	20.9	818322230**
22	600	64	78.4	10	19.6	41.8	818322232
22	900	96	117.6	15	29.4	62.7	818322234
22	1200	128	156.8	20	39.2	83.6	818322236
22	1500	160	196.0	25	49.0	104.5	818322238
28	300	37.5	64.0	5	19.3	40.2	818322830**
28	600	75.0	128.0	10	38.6	80.4	818322832
28	900	112.5	192.0	15	57.9	120.6	818322834
28	1200	150.0	256.0	20	77.2	160.8	818322836
28	1500	187.5	320.0	25	96.5	201.0	818322838

\* Intermediate lengths and extra-long bars on request

\*\* Connection thread on one end